

RMH-F060H030-3HP

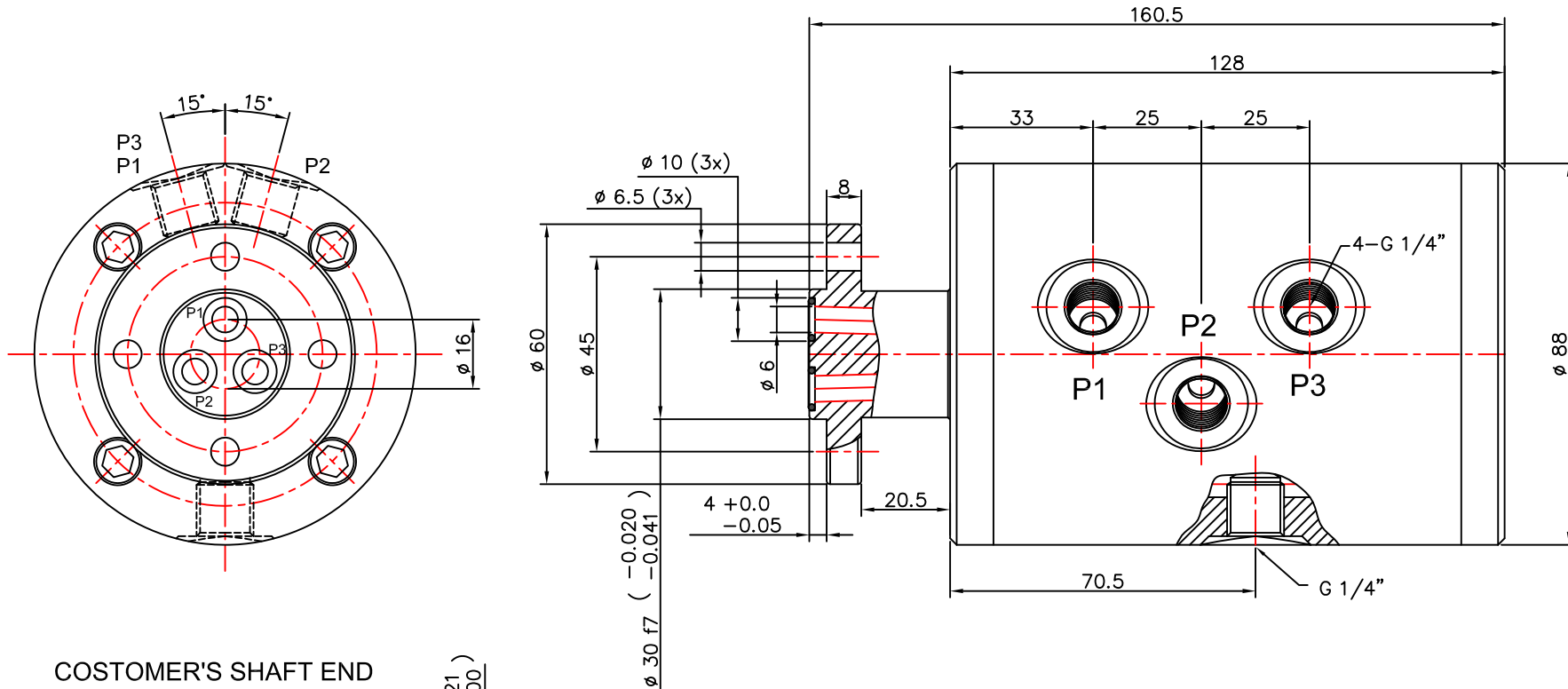

CUSTOMER'S SHAFT END

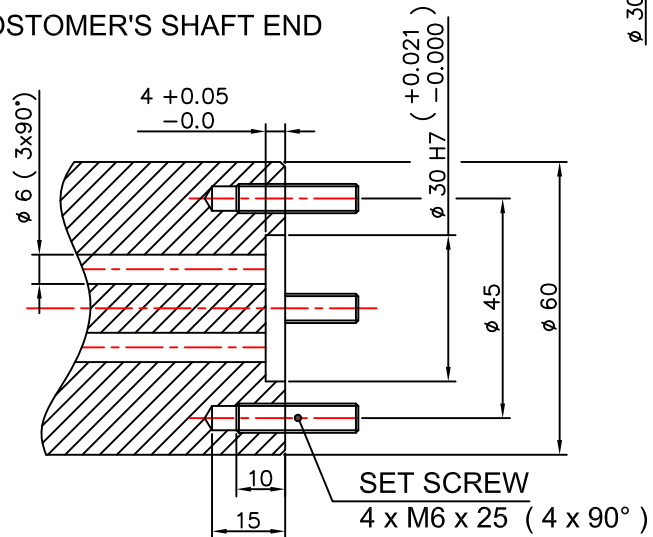

- Min. Hydraulic : 3 BAR
- Max. Hydraulic : 200 BAR
- Max. RPM : 3,000 rpm/min
- Max. Temp : 70 °C
- Max. Leakage at 40°(Load) : 4 l/min